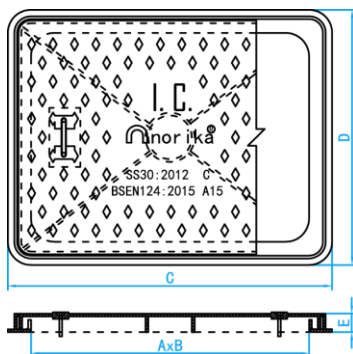
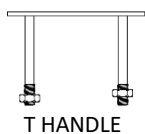
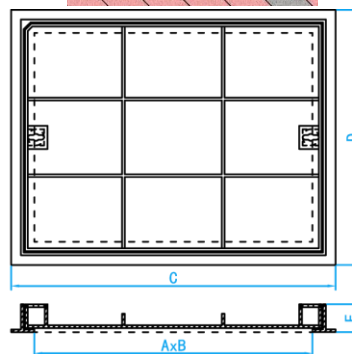
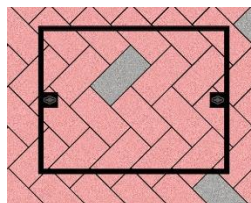
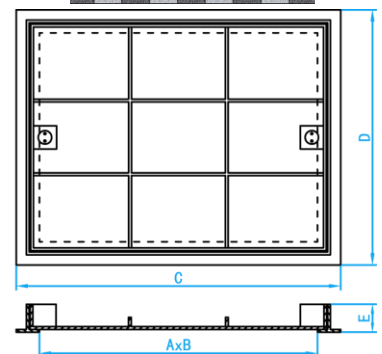
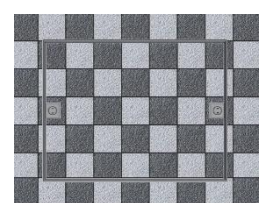

Type of Weight (Symbol)	SS30 Grade	Design Load	Place of Installation	EN124	Design Load
	AA1	900KN	In areas imposing particularly high wheel loads, eg. aircraft pavements.	F900	900KN
	AA2	600KN	In areas, generally not on public road imposing high wheel loads, e.g. docks, aircraft pavements.	E600	600KN
	A1	400KN	In carriageways of expressways, arterial, industrial roads and parking areas for all types of road vehicles.	D400	400KN
	A2	230KN	In carriageways not exceeding 0.5m away from kerb side channels of all roads and in carriageways of minor residential roads.	C250	230KN
	B	125KN	On footways where it is possible for a vehicle to mount or occasionally open to light vehicle to use and car parking decks.	B125	125KN
	C	30KN	In precincts which are inaccessible to motor vehicles.	A15	30KN

**Light Duty Inspection Chamber Cover & Frame**

**DIICCS**

**DIRICC**

**SSRICC & GIRICC**

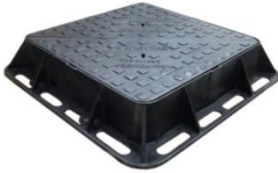
SKU	GRADE	MATERIAL	INTERNAL OPENING (AxB mm)	EXTERNAL (CxD mm)	HEIGHT (E mm)	Remarks/Optional
DIICCS	C	Ductile Iron	600x450	706x556	40	"T" Or "U" Handle
DIRICC	C	Ductile Iron	600x450	700x550	60	Recessed
SSRICC	C	Stainless Steel 304 / 316L	600x450	700x550	61	Recessed
GIRICC	C	Hot Dipped Galvanized Iron	600x450	700x550	61	Recessed

**Double Triangular Manhole Cover & Frame**
**P**

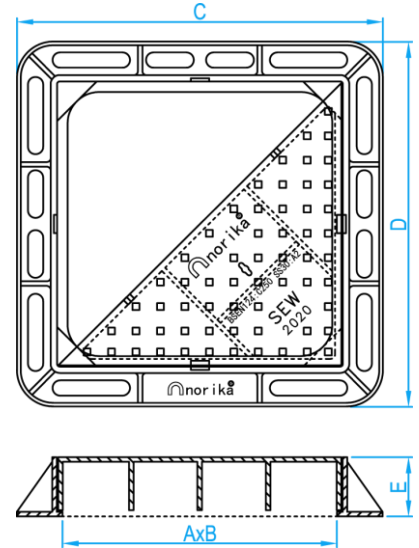
**DIMDMC**

**DIHDMC**

**DIMDMCA2**

**DIHDMCD400/ DIHDMCA1**

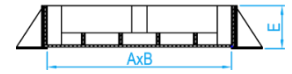
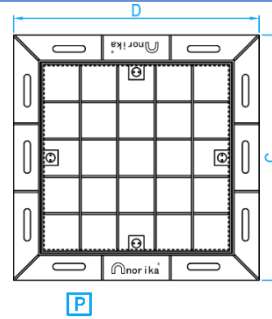
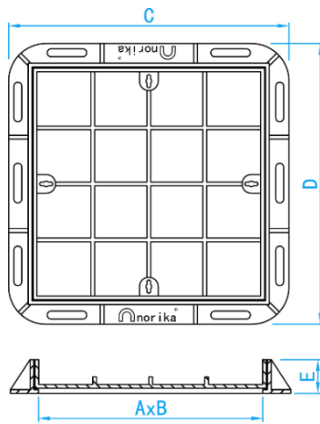
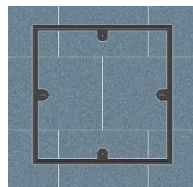
SKU	GRADE	MATERIAL	INTERNAL OPENING (Ax B mm)	EXTERNAL (Cx D mm)	HEIGHT (E mm)	Remarks/Optional
DIMDMC/ DIMDMCSEW	B	Ductile Iron	600x600	750x750	75	Medium Duty/ Medium Duty With "SEW" Label
DIHDMC/ DIHDMCSEW	A2	Ductile Iron	600x600	800x800	140	Heavy Duty/ Medium Duty With "SEW" Label
DIMDMCA2/ DIMDMCA2SEW	A2	Ductile Iron	600x600	750x750	90	Medium Duty/ Medium Duty With "SEW" Label
DIHDMCD400/ DIHDMCD400SEW	A1	Ductile Iron	600x600	800x800	140	Heavy Duty/ Medium Duty With "SEW" Label
DIHDMCA1 DIHDMCA1SEW	A1	Ductile Iron	600x600	800x800	140	Heavy Duty/ Heavy Duty With "SEW" Label

**Recessed/Mosaic Manhole Cover & Frame**

**DIMDRMCA2**

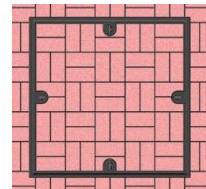
INSTALLATION EFFECT

**DIHDRMC**

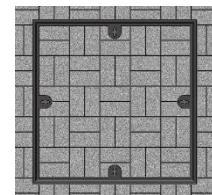
INSTALLATION EFFECT

**DIHDRMC-D400**

INSTALLATION EFFECT

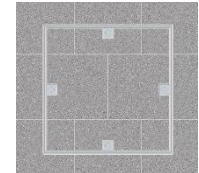
**SSMDRMC**

INSTALLATION EFFECT

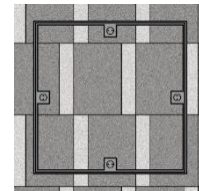

**SSHDRMC**

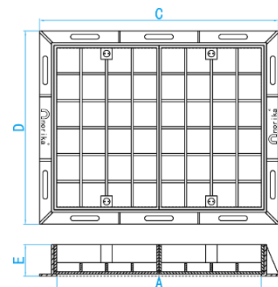
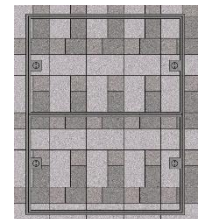
INSTALLATION EFFECT

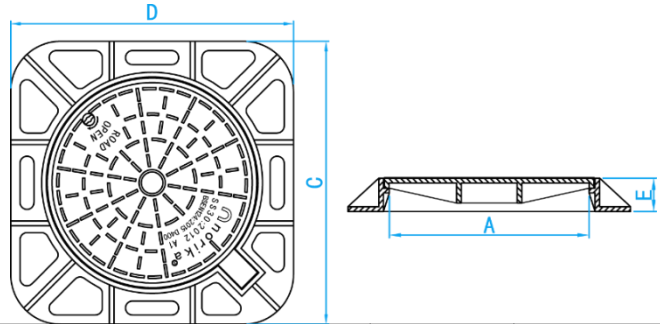

**SSHDTC-A1**

INSTALLATION EFFECT

SKU	GRADE	MATERIAL	INTERNAL OPENING (AxB mm)	EXTERNAL (CxD mm)	HEIGHT (E mm)	Remarks/Optional
SSMDRMC/ SSMDRMC316L	B	Stainless Steel 304/ Stainless Steel 316L	600x600	750x750	90	Medium Duty
DIMDRMCA2	A2	Ductile Iron	600x600	750x750	90	Heavy Duty
DIHDRMC	A2	Ductile Iron	600x600	800x800	140	Heavy Duty
SSHDRMC/ SSHDRMC316L	A2	Stainless Steel 304/ Stainless Steel 316L	600x600	800x800	140	Heavy Duty
DIHDRMC-D400	A1	Ductile Iron	600x600	800x800	140	Heavy Duty
SSHDTC-A1/ SSHDTC-A1316	A1	Stainless Steel 304/ Stainless Steel 316L	900x700	1050x850	140	Heavy Duty

**Circular Manhole Cover & Square Frame**

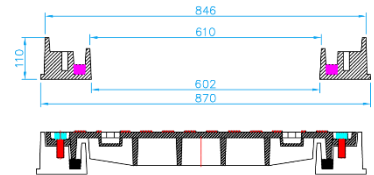
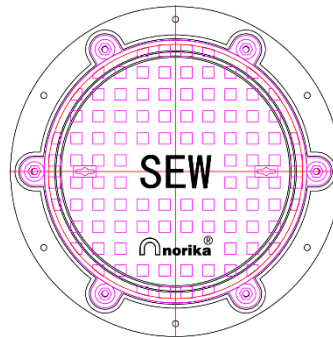
SKU	GRADE	MATERIAL	INTERNAL OPENING (A mm)	EXTERNAL (Cx D mm)	HEIGHT (E mm)	Remarks/Optional
DIMC	A1	Ductile Iron	Ø600	850x850	100	-

**Air/Water Tight Manhole Cover & Frame**

SKU	GRADE	MATERIAL	INTERNAL OPENING (mm)	EXTERNAL (mm)	HEIGHT (mm)	Remarks/Optional
DIMCATD400-R0600	A1	Ductile Iron	Ø600	Ø870	110	Air-Water Tight

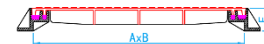
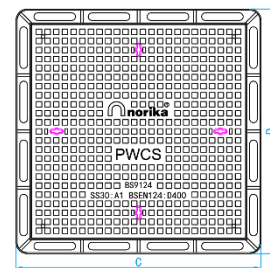
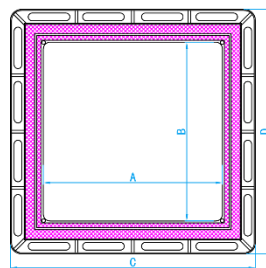

SKU	GRADE	MATERIAL	INTERNAL OPENING (Ax B mm)	EXTERNAL (Cx D mm)	HEIGHT (E mm)	Remarks/Optional
DIMCATD400-0600	A1	Ductile Iron	600x600	890x890	140	Air-Water Tight/ Air-Water Tight With "PWCS" Label
DIMCATD400-0800	A1	Ductile Iron	800x800	1080x1090	140	
DIMCATD400-09100610	A1	Ductile Iron	910x610	1200x900	100	
DIMCATD400-1000	A1	Ductile Iron	1000x1000	1280x1280	100	
DIMCATD400-12001000	A1	Ductile Iron	1200x1000	1520x1320	100	

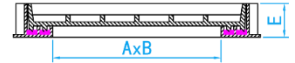
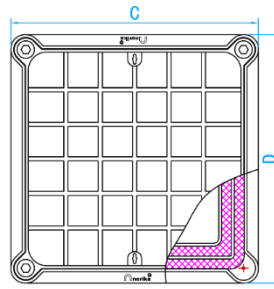
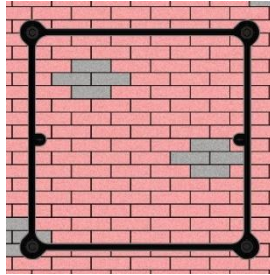
**Air-Water Tight/ Recessed-Mosaic Manhole Cover & Frame**

**INSTALLATION EFFECT**

SKU	GRADE	MATERIAL	INTERNAL OPENING (AxB mm)	EXTERNAL (CxD mm)	HEIGHT (E mm)	Remarks/Optional
DIMCATRD400-0600	A1	Ductile Iron	600x600	882x882	120	Air / Water Tight
DIMCATRD400-0800	A1	Ductile Iron	800 x 800	1082 x 1082	120	Air / Water Tight
DIMCATRD400-1000	A1	Ductile Iron	1000 x 1000	1282 x1282	120	Air / Water Tight

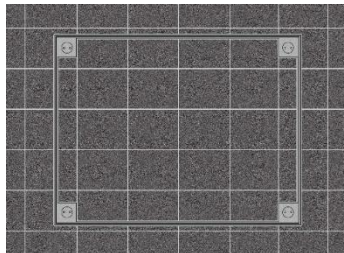
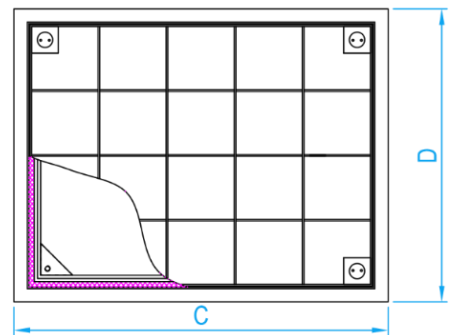
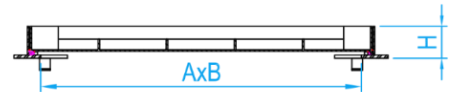

SSRICCAT/ SSRICAT316L

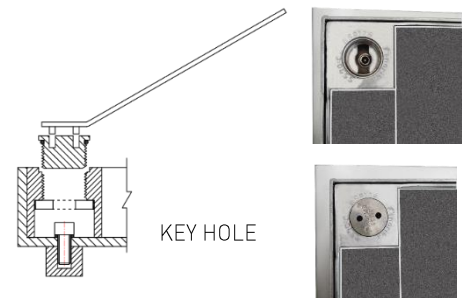
**INSTALLATION EFFECT**

 SSHDRMCAT-A1/  
SSHDRMCAT316L-A1

**INSTALLATION EFFECT**

**KEY HOLE**

Note: 4 bolts and rubber seal to ensure airtight and watertight.

**Norika designed keyhole system**

SKU	GRADE	MATERIAL	INTERNAL OPENING (AxB mm)	EXTERNAL (CxD mm)	HEIGHT (E mm)	Remarks/Optional
SSRICCAT	C	Stainless Steel 304	600x450	700x550	61	Air-Water Tight
SSRICCAT316L	C	Stainless Steel 316L	600x450	700x550	61	Air-Water Tight
SSHDRMCAT-A1	A1	Stainless Steel 304	600 x 600	800 x 800	140	Air-Water Tight
SSHDRMCAT316L-A1	A1	Stainless Steel 316L	600 x 600	800 x 800	140	Air-Water Tight